

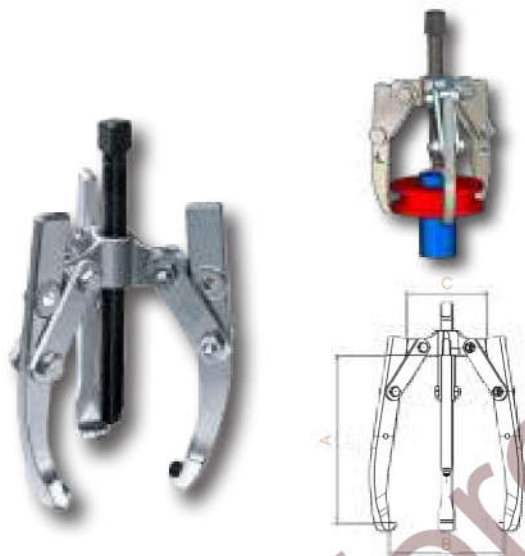



**Extractor 2/3 patas oscilantes / 2/3 oscillating jaws pullers**

**Serie 1300T**



Combina con 2/3 patas



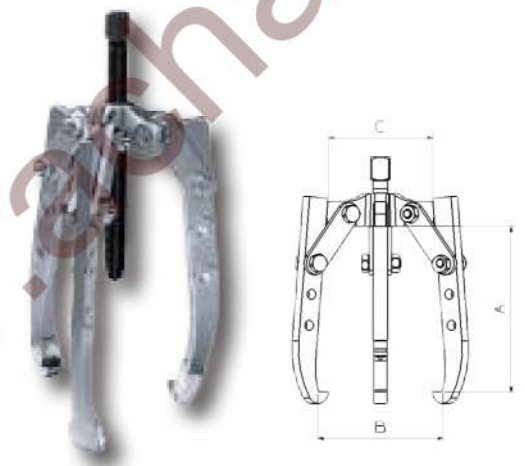

Ref.	€/u.	A	B	C				
1300T	47,10	55	70	37	-	0,3	130003	130005
1301T	63,20	85	100	80	✓	0,7	130103	130105
1304T	94,60	135	150	104	✓	1,8	130403	130405
1307T	126,00	180	200	108	✓	3,3	130703	130705
1308T	142,40	180	250	160	✓	3,7	130703	130705
1310T	298,80	300	310	161	✓	7,5	131031	131005
1317T	514,90	370	425	280	-	17,0	131731	131705
1330T	965,90	460	520	325	-	33,5	133031	133005
1350T	1.649,00	750	800	402	-	65,0	135032	135005

**Extractor 2/3 patas largas oscilantes / 2/3 oscillating long jaws pullers**

**Serie 1300LT**



Combina con 2/3 patas

Ref.	€/u.	A	B	C				
1300LT	52,80	70	90	37	-	0,3	130003	130006
1301LT	68,60	105	110	80	✓	0,7	130103	130106
1304LT	102,70	185	175	104	✓	2,1	130403	130406
1307LT	137,70	225	240	108	✓	3,5	130703	130706
1308LT	154,10	225	290	160	✓	3,9	130703	130706
1310LT	310,50	400	350	161	✓	8,5	131031	131006
1317LT	561,70	480	480	280	-	18,5	131731	131706
1330LT	1.027,10	590	650	325	-	39,0	133031	133006
1350LT	1.820,00	900	980	402	-	75,0	135032	135206

L = Pata serie larga, mayor capacidad.



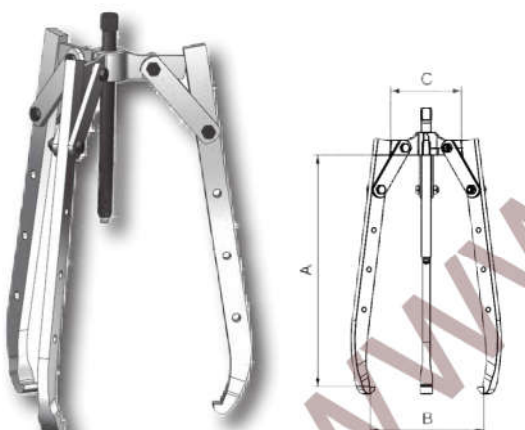

L = Long jaw, bigger capacity.

**Extractor 2/3 patas extra largas oscilantes / 2/3 oscillating extra long jaws puller**

**Serie 1300XT**



Combina con 2/3 patas

Ref.	€/u.	A	B	C				
1310XT	357,90	480	405	161	✓	10,9	131031	131016
1317XT	618,00	595	540	280	-	20,5	131731	131716
1330XT	1.078,10	710	720	325	-	45,5	133031	133016
1350XT	1.916,00	1.050	1.080	402	-	85,5	135032	135216

X = Pata serie extra - larga, mayor capacidad.

X = Extra - long jaw, bigger capacity.