

# MODEL 100 PROFESSIONAL 1/2" SQ DR REVERSIBLE RATCHET

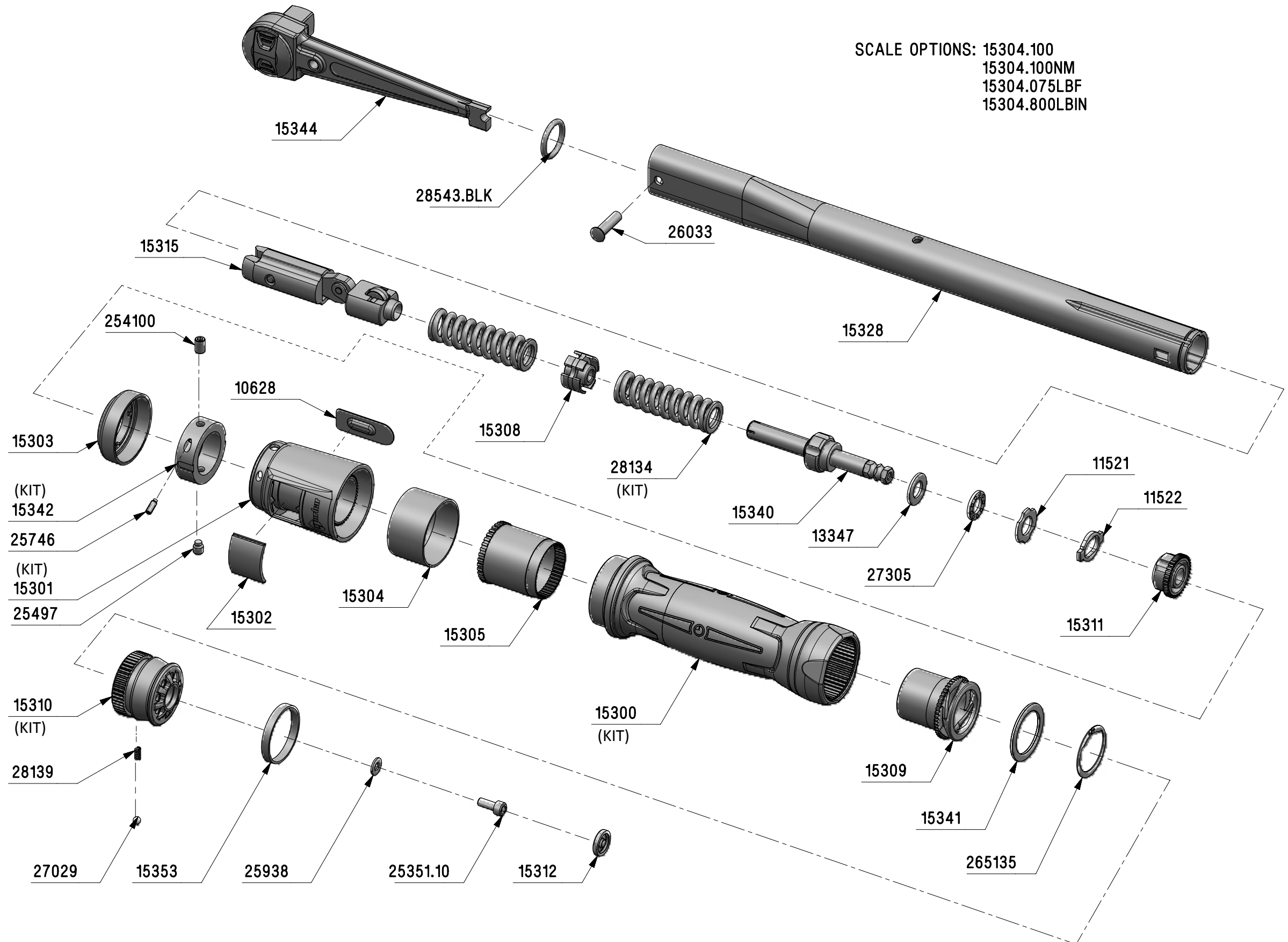

# MODEL 100 PROFESSIONAL 1/2" SQ DR REVERSIBLE RATCHET

15344	1	REVERSIBLE RATCHET MDL 100 1/2" SQ DR
10628	1	TIMESTRIP LABEL 12 X 33
25746	1	M3 DOG POINT GRUB SCREW T6 TORX DRIVEN
254100	1	SCR SKT GRUB M5 x 8 LONG OVAL
15302	1	SCALE LENS
27029	1	3.8 MM STEEL BALL
28139	1	SPRG/COMP PROFESSIONAL LOCKING KNOB
15312	1	END CAP
25351.10	1	SHCS M4 x 10 - 12.9 TO ISO 4762
25938	1	WASHER M4 STD. FLAT TO DIN125/ISO7089
15353	1	NOTIFICATION BAND
15328	1	MODEL 100 PROFESSIONAL BODY TUBE
15342	1	THRUST WASHER SIDE LOCKING
25497	1	SSS M5X5LG DOG POINT -12.9 TO ISO4028
15301	1	SCALE MECHANISM COVER
15305	1	SCALE ROTATING GEAR
15300	1	TWO SHOT HANDLE
15309	1	CLEARANCE REMOVAL SHAFT
15341	1	PUSH PLATE
265135	1	CIRCLIP HANDLE RETENTION PROFESSIONAL
11522	1	END STOP
15310	1	LOCKING KNOB
15311	1	STATIONARY LOCKING GEAR
11521	1	SHAPED WASHER
27305	1	SPECIAL THRUST BEARING FOR TORQUE WRENCHES
13347	1	TRUTORQUE HARDENED WASHER
15340	1	ADJUSTING SCREW ASSEMBLY NEW PROFESSIONAL
15308	1	SPRING CONNECTING PLATE
28134	2	MAIN COMPRESSION SPRING NEW PROFESSIONAL
26033	1	PIVOT PIN TES 3487
28543.BLK	1	O RING 15.54 ID 2.62 SECT BLACK
15303	1	SCALE MECH COVER CAP
15304	1	SCALE DISPLAY SLEEVE
15315	1	SECONDARY MOTION ASSEMBLY
Part No	Qty	Description

